

# MHUB

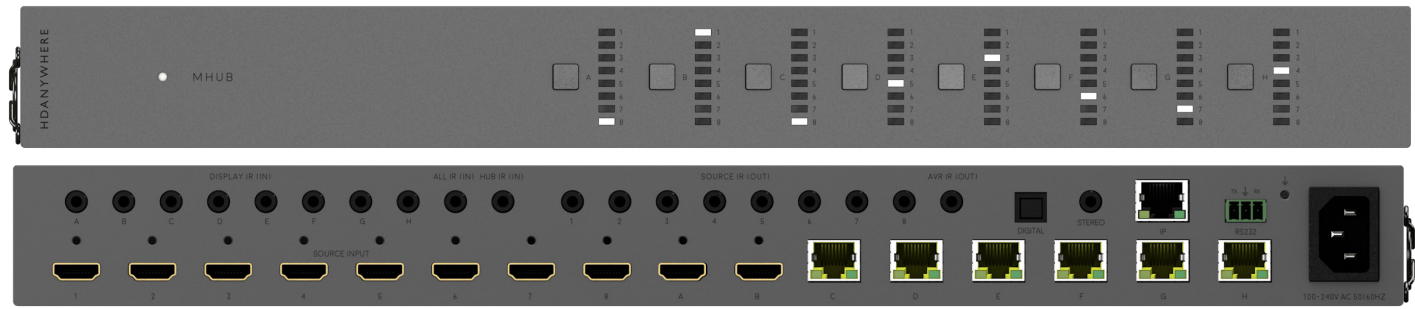

PRODUCT CODE: MHUB862U



# CONTENTS

Box contents and system introduction	2
System features	2
Matrix hub rear connections	3
Matrix hub front and display receiver connections	4
Wiring diagram	5
Setup	6-10
- Cables & wiring	6
- Setting up IR control	7
- Testing your IR set up	7
- Gaining IR control of sources	8
- MHUB-OS First Boot Process	9-10
Operation	11
Specifications	12

## IN THE BOX

- 1x MHUB (8x6+2) matrix hub
- 6x MHUB display receivers
- 1x MHUB infra-red (IR) remote control
- 1x IEC power lead
- 9x IR RX
- 15x IR TX
- 2x 19" rack mounting ears

## SYSTEM: MHUB

Cloud-monitorable 8x6+2 HDMI / HDBT+HDMI matrix system with a 40m UHD 4K or 70m 1080p transmission range. An integrated IP>IR control processor enables property-wide control off all the connected sources and displays via the free uControl universal remote App or Alexa voice commands.

Multichannel audio or stereo extraction can be selected to occur matched to any of the display zone output. Remote cloud monitoring is also possible, designed to reduce the necessity for callouts and site visits.

**Please fully read and adhere to the setup information and operational instructions contained within this installation manual.**

## SYSTEM FEATURES

HDMI® 2.0 features supported up to 18Gbps

All display receivers powered via PoH

Web GUI for easy config and setup (MHUB-OS)

Remote system monitoring (HDA Cloud)

Advanced EDID management

Supports HDCP 2.2 Ultra HD 4K 60Hz 4:4:4

Support for HDR10, Dolby Vision and HLG.

Supports all current audio formats up to and including Dolby Atmos® and DTS:X®

Multichannel audio or stereo extraction via digi coax, or via 3.5mm stereo jack

4K>1080 down/up-scaling receiver option available

2/3-year guarantee (Cloud registration required)

# MHUB (8x6+2) REAR CONNECTIONS

1. "SOURCE INPUTS" [1-8]: Use to connect HDMI source devices to the MHUB

2. HDMI Outputs [A-B]: Connect a display to this port via a HDMI cable

3. HDBaseT Outputs [C-H]: Connect your MHUB receivers to these ports via a CAT cable

4. "DISPLAY IR (IN)" [A-H]: Connect IR RXs to these ports to control your displays via IR with a third party control system

5. "ALL IR (IN)": Connect an IR RX to this port to send commands to all displays simultaneously

6. "HUB IR (IN)": Connect an IR RX to this port to control your MHUB with the included IR remote control (or other learning remote) whilst in line-of-sight of the IR RX.  
Or control the MHUB with a third party controller via direct IR, using the optional add-on accessory called the 'MHUB IR integration cable'. (1.55.911.001.1)

7. "SOURCE IR (OUT)" [1-8]: Connect IR TXs to these ports to control your source devices via IR. The "SOURCE IR" port number corresponds with the source input number

8. "AVR IR (OUT)": If you have an AVR in your system, connect an IR TX to this port and place it on the IR window of your AVR

9. Audio Extraction Ports:

a. "DIGITAL" Audio: Use this port to extract multi-channel audio via an optical cable

b. "STEREO" Audio: Use this port to extract stereo audio via a 3.5mm jack cable

10. "HUB CONTROL IP" Port: Connect the MHUB system to your router via this port to enable controllability via TCP/IP commands, web GUI access and system control via the uControl App.

11. "RS232" Port: Use to integrate your MHUB with a control system via RS232

12. AC input: Connect the supplied IEC power cable to this port to provide power to your matrix

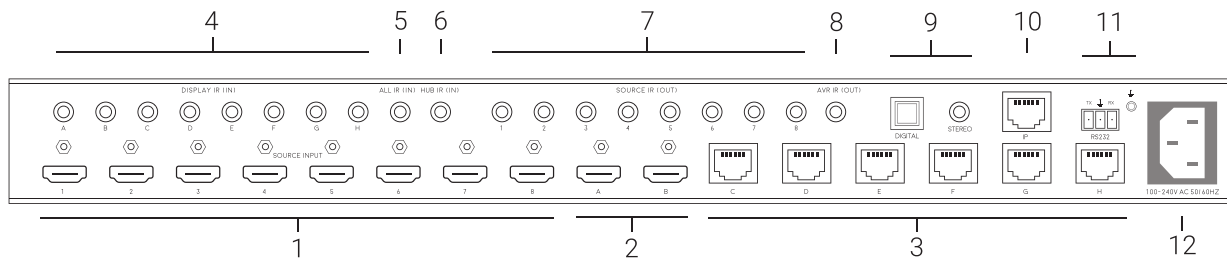

# MHUB (8x6+2) FRONT PANEL

1. Power LED: If this is lit up your matrix is receiving power

2. Source Selector [1-8]: Select which source you want to switch to via the button

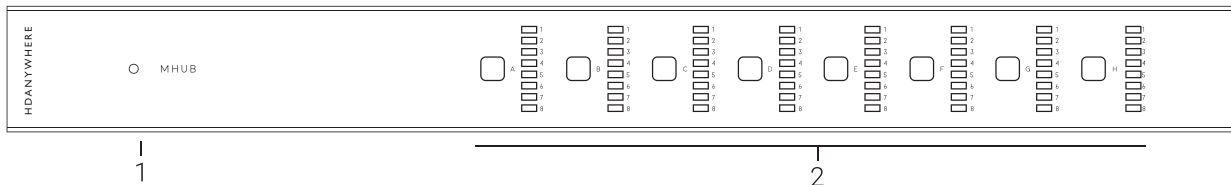

# DISPLAY RECEIVERS

1. Optional DC input: Plug a 24V / 1A DC power supply into the unit if you are not using PoH

2. HDBASET: connects back to the HDBASET output on the MHUB chassis

3. "HDMI OUT": Connect this to your local display using a HDMI cable



4. "IR IN": Connect an IR RX to the 'IR (IN)' port to send IR commands back to the MHUB chassis

5. "IR OUT": Connect an IR TX to enable control of your display

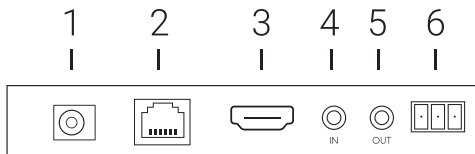
6. Service Port



# WIRING DIAGRAM

- HDMI Cable
- Ethernet Cable
- Digi-Coax Cable
- HDBaseT
- IR Receiver
-  IR Receiver
-  IR Signal

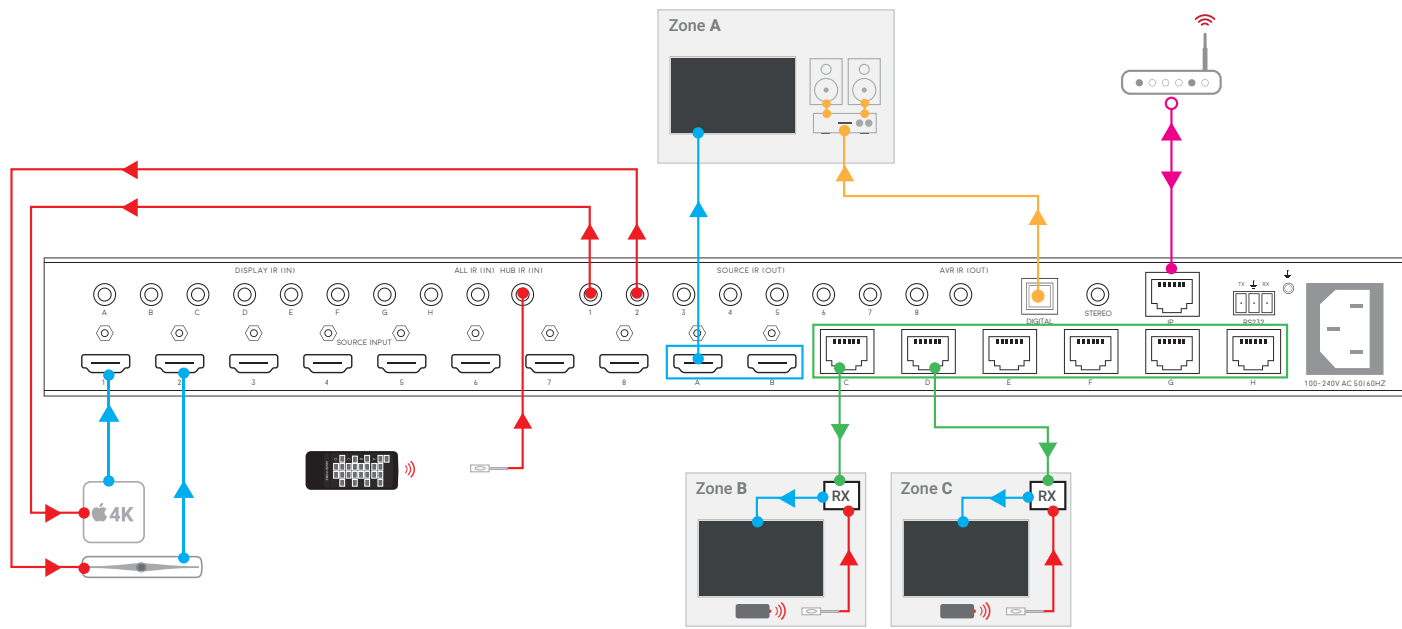

# CABLES & WIRING

## Notes on your network cabling

Currently you can use Cat5e, Cat6, Cat6e, Cat6a, Cat7 or Cat7a with HDA products.  
DO NOT USE COPPER CLAD ALUMINIUM (CCA) Cat 5/6/7 CABLE.

The baseline cable standard for HDanywhere systems is Cat5e. Greater distances and reliability can be achieved by using Cat6, or slightly better still with the Cat7, which have thicker copper cores and shielding for easier signal transfer.

## Optimum performance

Whichever network cable type you choose, ensure that the main wiring architecture is 'solid core', not stranded 'patch' cabling. Patch cabling can be used for the last few metres of a run (say from a wallplate) but should be avoided over the longer runs as signal transfer over stranded cores is heavily reduced. The use of pre-made leads is not recommended unless you can be absolutely sure of their construction credentials (i.e. solid core 568B). For absolute optimum performance, use a single piece of Cat cable terminated directly at the transmitter and the receiver ends. Make sure to use the correct connector types i.e. RJ45 solid core crimp connectors.

## Shielded cables

Unlike other systems, shielded FTP cable is not a stipulation. If however you preferred this type of cable please ensure compatible shielded accessories are used. Failure to terminate cable screen at all points can induce interference rather than eliminating it.

## Patch panels and wall plates

If the patch panels are terminated correctly, there is minimal loss of distance, however the use of wallplates and patch panels has the potential to cause increased resistance on the cable, introducing pinch points for signal transmission, and could reduce advertised transmission lengths.

**TIP – instead of using RJ45 wallplates, use brush plates instead to maintain the neat finish.  
A search for "brush plates" will yield many results.**

## Connection termination

Terminate the cabling using RJ45 connectors to the 568B wiring standard (shown below).

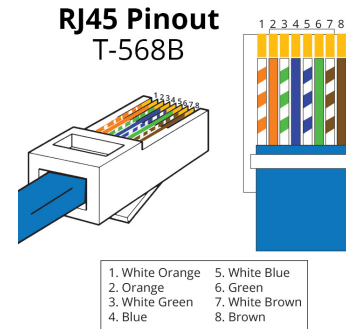

## Notes on your HDMI cabling

HDANYWHERE recommends using suitably robust, good quality HDMI cables. It is not advised to use passive HDMI cables over 5 metres in length either on the inputs or the outputs of the matrix hub or display receivers.

In circumstances where HDMI cables longer than 5 metres are required, HDA recommends utilising an Active HDMI cable option, optical-fibre or similar.

## SETTING UP IR CONTROL

This will enable backwards IR control (the most common form of IR control) where IR signals from a remote in any one of your rooms is sent back to the central hub and sent to your source device to make it appear as though it is in the same room as you.

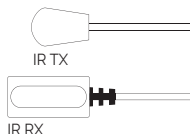

### Source control via IR (backwards IR)

1. Plug IR Transmitter TX into the numbered 3.5mm jack port labelled SOURCE IR (OUT) on the MHUB. Make sure the number corresponds with the HDMI input the source device is connected to
2. Place IR Transmitter TX bud (small tear drop part) in front of the IR eye of the source (where you would normally point the remote to control the HDMI source device). Repeat these steps for each source device
3. Plug IR Receiver RX into the 3.5mm jack port labelled IR IN on the display receiver
4. Place IR Receiver at or near the display (position it close to where you would usually point your remote to turn your TV on or off)

### Display control via IR (forwards IR)

1. Plug IR Transmitter TX into the 3.5mm jack port labelled IR OUT on the display Receiver
2. Place IR Transmitter TX in front of the IR eye of the display (position it where you would usually point your remote to turn on or off your TV)
3. Plug IR Receiver RX into the numbered 3.5mm jack port labelled DISPLAY IR on the central hub. Make sure the number corresponds with the display you want to control
4. Place IR Receiver in a visible uncovered position where it is able to receive remote signals

## TESTING YOUR IR SET UP

### Test basic operation (backwards IR)

The easiest way to verify your IR setup is to go to your display device connected to output b (or your first connected output) of the central hub. Use the matrix remote to select source input 1 and then use the remote control for your chosen source 1 to verify control. Do this for each of the other sources connected to the matrix. If you wish, you can then repeat the process at each of the display locations you have connected to the system.

### Forward IR ports

MHUB has forward IR ports on the rear of the matrix. These allow IR signals to be sent from the central hub to the individual TV receivers. This feature is for use when integrating with third party control systems. In normal use these ports are not used or required. For example, a third party smart home system such as Control4, Crestron, AMX or RTI can send IR commands to control devices at the TV receiver location from the location of the central hub.

### Working with identical source devices

MHUB has discrete IR, so it is possible to have two or more identical source devices without IR clashes that result in the operation of all identical devices. When using two or more identical source devices, please take measures to avoid IR transmission leaks that could cause the other identical source devices to respond. You can take measures to shield source devices from the IR being emitted by other source device IR TX emitters by locating them on different shelves, for example.

## Gaining IR control of sources when using a direct HDMI connected display, or an XTND extender set with MHUB.

- A. The HDMI IR dongle is included with MHUB as part of the boxed package.
- B. The 'MHUB+XTND Integration Kit' is available as an optional extra accessory. (2.50.792)

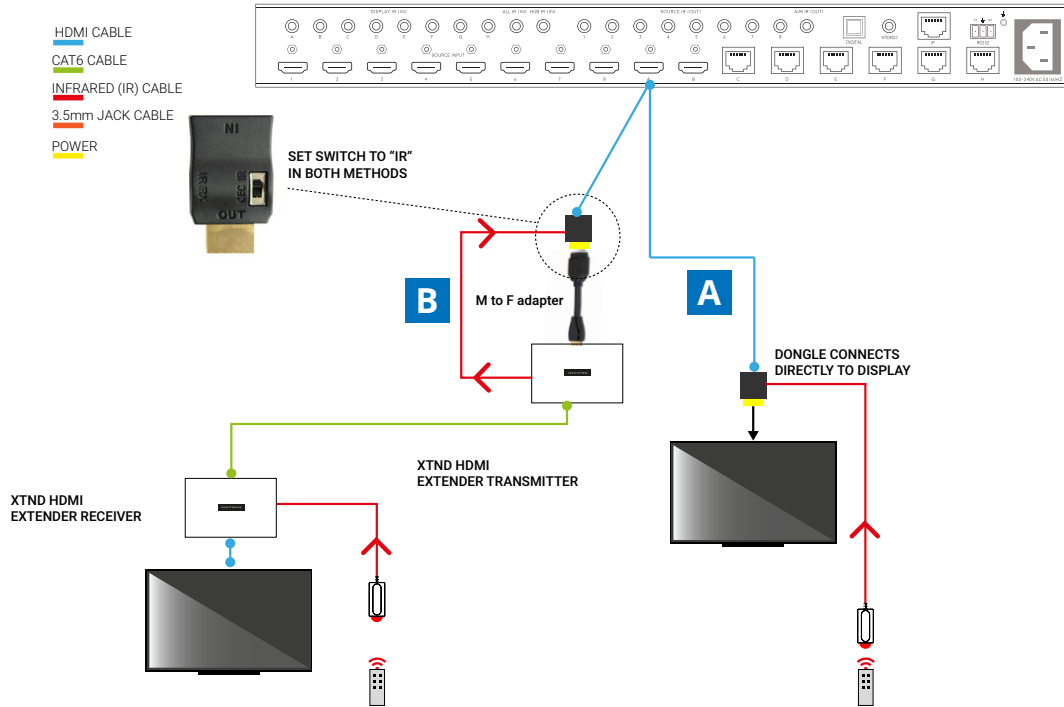



# SETUP CONTINUED...

1. Power off all displays and all HDMI source devices.
2. Connect the unpowered HDMI sources to the HDMI inputs on the matrix hub.
3. Connect each display receiver's Cat cable to the HDBaseT ports on the matrix hub.
4. Connect any direct devices such as AVRs or displays to the HDMI ports on the matrix hub.
5. Plug in the power for the matrix hub.
6. Power on each HDMI source device followed by each display.
7. At this point the four displays should show the video and audio of the HDMI source devices connected to the matrix.

## MHUB-OS FIRST BOOT PROCESS

Make sure MHUB is connected up correctly before starting the first boot process on MHUB-OS. HDANYWHERE(HDA) recommends that every MHUB install goes through its first boot process to ensure that the MHUB is setup correctly. Please follow the quick start guide (inside MHUB packaging) to make sure your MHUB is connected correctly to your source devices, displays and has an active network connection before proceeding.

### I don't use MHUB-OS or go through the first boot process, will it still work like a normal matrix?

Yes. You do not need to access MHUB-OS if you don't want to. MHUB will work distributing video as normal and will be controllable using the included remote controls. Please note that you will not be able to access advanced features such as voice control, the uControl app or build Sequences.

### Accessing MHUB-OS (MOS)

There are two ways to access MOS:

1. Download our app, uControl, from the iOS or Google Play Store and let it find MHUB (and run you through the first boot) for you.

2. Use a network scanner such as <https://www.fing.io/> to discover the devices connected to the network. Find MHUB in the list of devices and the IP address associated to it from there. Make a note of it then put that address into any web browser on the same network. You will be forwarded to your MHUB-OS and prompted to complete the first boot process.

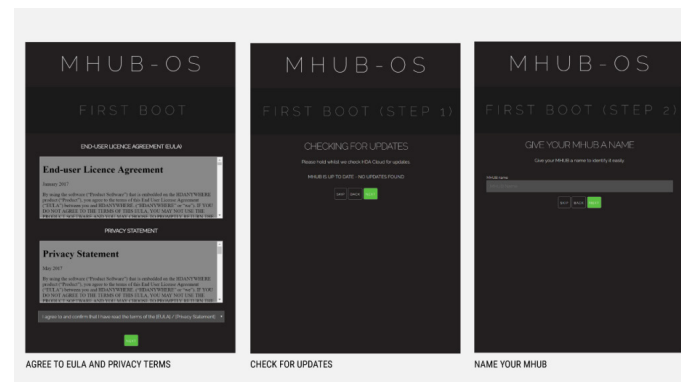

**BEFORE STARTING:** Read and agree to the End User Licence Agreement (EULA) and Privacy Statement

### First Boot Step 1 – Check for MOS updates

This is where your MHUB requests available updates from HDA cloud so your unit will update to the latest version. This is done before proceeding.

### First Boot Step 2 – Name your MHUB

Here you can give your MHUB a personal name, this can also be used to differentiate multiple installations by HDA Pro's

### First Boot Step 3 – Name your sources/inputs

On this page you can label your input devices, such as Sky, Apple or Tivo. These labels are used in the uControl app and with voice control.

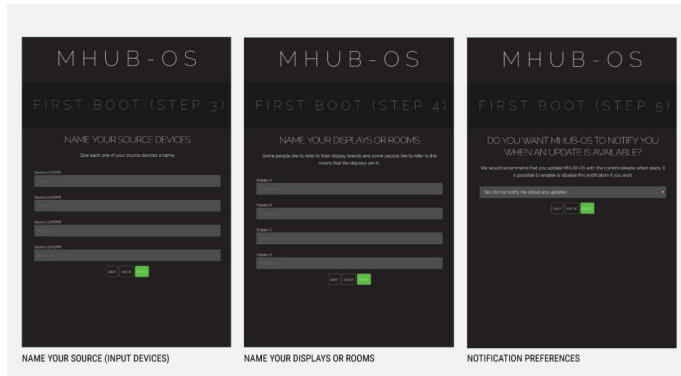

#### First Boot Step 4 – Name your Displays/Rooms/outputs

This page is similar to the previous step. You can choose to label them as display manufacturers or room names. Again please follow best practice guidelines available here – [Best Practices]

#### First Boot Step 5 – Turn update notifications On/Off

MOS updates are released periodically, here you can choose to be notified when an update is available.

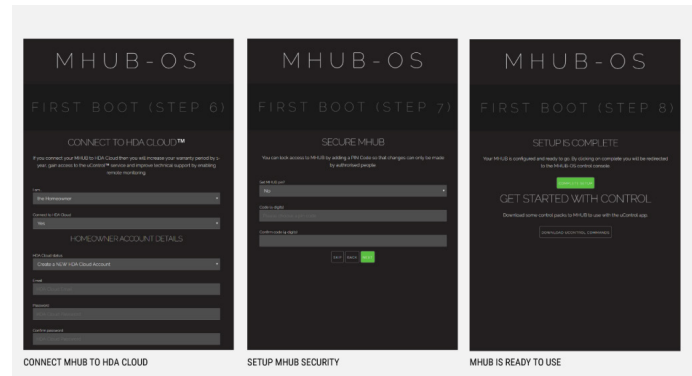

#### First Boot Step 6 – Create or link your MHUB to a HDA cloud account, read and agree to our Terms and Conditions

MHUB 4K and MHUB 4K PRO units can be linked to a cloud based account. When registering as a homeowner this enables a couple of things. Firstly when you register, your warranty period is extended by 1 year, in addition to that cloud access is required when using the uControl IR engine feature allowing you to control source and display devices. Cloud access is also required for voice integration. For a HDA PRO the cloud account allows you to manage your MHUB installations remotely, getting system information as well as a host of other features.

#### First Boot Step 7 – Secure MHUB with a PIN number

If you wish you can lock local access to MOS stopping any unwanted configuration changes from being made.

#### First Boot Step 8 – Complete First Boot Setup

Once you have completed the first boot process you can either 'COMPLETE SETUP' and go to the MOS DASHBOARD page, or go to the uControl page to start adding device/source control.

# OPERATION

## Via the front panel

You can switch between connected HDMI sources (1-8) at displays (A-H) manually by using the buttons on the front of the matrix hub. Pressing the button next to the corresponding output will cycle through the available source devices.

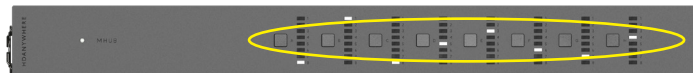

## Using the Master or Room Remote

To control MHUB using the master remote, connect the included IR RX cable to the 3.5mm jack port labelled 'HUB IR'



### Contextual IR and Room Remotes

MHUB receives infrared (IR) commands from display receivers 'contextually', with the unit determining which zone output the IR command originated from. Contextual IR enables the ability to use simplified remotes with less buttons compared the Master Remote, which HDA call 'Room Remotes'. Contextual IR gives the ability to roam a property from zone-to-zone with the same Room Remote, and when you use it, the MHUB knows exactly which zone you are requiring control at.

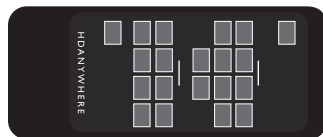

1x included, additional room remotes sold separately (1.65.904.006.1)

## Integrating and operating MHUB with a third party control system

The MHUB can be integrated with a third party control system via IP or RS232. Drivers for the most popular brands can be found on the MHUB MAX product page on our online support site. <http://support.hdanywhere.com/products/multiroom-hd/mhubmax/>

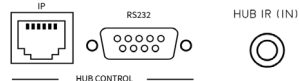

It is possible to control MHUB with a third party controller via direct IR, using the optional add-on accessory called the 'IR integration cable' (1.55.911.001.1)

## The HDANYWHERE uControl App

Download the free HDANYWHERE uControl App to your phone or tablet. With uControl and the MHUB MAX you can control which source is being routed to what display.

It is highly recommended that you learn more about uControl at HDANYWHERE.com or visit the dedicated uControl support pages at <http://support.hdanywhere.com/ucontrol/>



## SPECIFICATIONS

These specifications may change or be improved without notice. HDANYWHERE may not be held responsible for discrepancies.

Form factor	19"/1U aluminum rack-mountable unit
Inputs x outputs	4 HDMI x 3 RJ45 HDBaseT + 1 HDMI
Transmission tech.	HDBaseT Class B and HDMI
Video bandwidth	340MHz clock / 10.2Gbps data
ESD protection	± 8kV (air-gap discharge) ± 4kV (contact discharge)
Hub control	Web GUI, IR, TCP/IP, RS232, App, Alexa
App control	Full control over sources, matrix hub & display functions.
Device weight	2400g
Package weight	3500g
Dimensions (W/D/H)	Hub 440 / 284 / 43 mm (without feet) RX 163 / 94 / 18 mm
Power	Internal 110-240v IEC connection
Guarantee	2/3-year guarantee (Cloud registration required)
Operating temperature	32°F to 104°F (0°C to 40°C)
Storage temperature	-4°F to 140°F (-20°C to 60°C)
Relative humidity	20~90 % RH (non-condensing)
Power consumption	30W (max) 0.5W (standby)

## IMPORTANT INFORMATION

### Terms and Policies, including General Data Protection Regulation (GDPR) and other Data Protection Laws.

During the setup process of this device, the HDA Pro (Installer) and End-User are required to agree to a set of terms, conditions, rules, policies and license agreements, including the HDANYWHERE Privacy Policy. These terms, notices and policies are, collectively, the "Agreements". By installing or using this MHUB, you agree to be bound by the Agreements.

### EU Conformity

Hereby, HDANYWHERE declares that this HDMI connectivity device is in compliance with the essential requirements and other relevant provisions of the following Directives: 2006/95/EC (LVD Directive); 2004/108/EC (EMC Directive); 1999/5/EC (R&TTE Directive). The full text of the EU declaration of conformity is available in the compliance section at [HDANYWHERE.com/legals](https://www.hdanywhere.com/legals)

### Recycling your device properly

In some areas, the disposal of certain electronic devices is regulated. Make sure you dispose of or recycle your device in accordance with your local laws and regulations.



# HDANYWHERE LIMITED PRODUCT (2/3 YEAR) GUARANTEE

## WHO WE ARE

1. We are HD CONNECTIVITY LTD trading as HDANYWHERE ("HDA"), a limited company registered under number 06046737 in England and Wales with its registered offices at Unit 23 Link Business Centre, Link Way, Malvern, Worcestershire, WR14 1UQ.

## OUR GUARANTEE TO YOU

2. We, HDANYWHERE warrant to you, the end user [MG1] of the HDA hardware (the "Products") that on the date of delivery of the Products to you, and for a period of 3 years from that date of delivery, the Products shall:

- match any description that has been provided to you;
- be free from any significant defects in their design, the materials used to make them, and the way they are made;
- be of satisfactory quality (within the meaning of the Consumer Rights Act 2015); and
- be fit for any purpose held out by us.

This 2 year period, or, if the period has been extending to 3 years in accordance with paragraph 3, will be the "Guarantee Period". We offer this guarantee to all our customers who are resident and have an address in Great Britain and Northern Ireland. [MG2]

## EXTENDING YOUR GUARANTEE

3. On registering your Products with the HDA Cloud, the guarantee offered in paragraph 2 by us will automatically extend for a period of one year, provided that your registration takes place within 30 days from the date of delivery. The one year guarantee extension starts automatically from the date that the original 2 year guarantee ends.

## HOW TO CLAIM ON YOUR GUARANTEE AND YOUR REMEDIES

4. Subject to paragraphs 5 and 6 of this guarantee, Your sole remedies under Our guarantee to You are as follows:
- Up to 30 days: we will repair or replace your Products or provide you with a full refund of the price of the defective Products at your option.
  - Up to 6 Months: we will repair or replace your Products. If we are unable to repair or replace your Products we will provide you with a full refund of the price of the defective Products.
  - Up to 2 (3) Years: we will repair or replace your Products. If we are unable to repair or replace your Products we will provide you with a partial refund of the price of the defective Products based upon the devaluation of the Products since the time of purchase.
5. In order to claim under the guarantee given to you in paragraph 2 you will need to:
- give us notice in writing of your intention to claim under the guarantee during the Guarantee Period, and do so within a reasonable time after finding that some or all of the Products do not comply with the guarantee set out in paragraph 2;
  - show that the Products that you claim are defective, have been examined by a HDA Pro or other authorised or suitably qualified installer, and that they have [MG3] confirmed in writing that the suspected defect in the Products stems solely from a fault in the HDA hardware;
  - give us a reasonable opportunity to examine the Products in question;
  - provide us with an order number and a dated sales or delivery receipt from an HDA Distributor, HDA Pro or other authorised dealer, reseller or installer of the Products.
  - obtain from us in advance of returning the Products a return merchandise authorisation and/or case number [MG4]; and
  - (if asked to do so by us) return such Products to our place of business at our cost.

## CIRCUMSTANCES WHERE YOUR GUARANTEE DOESN'T APPLY

6. We shall not be liable for the Products' failure to comply with the guarantee set out in paragraph 2 in any of the following events:
- If you make any further use of the Products after giving us notice of an issue in accordance with paragraph 5;
  - the defect arises because you failed to follow our oral or written instructions as to the storage, installation [MG5], use and maintenance of the Products;
  - the defect arises as a result of your use of the Products with any other software or hardware that is not compatible with the Products;
  - the products are used by you for any commercial purpose, including rental or demonstrative purposes;
  - you alter or repair the Products without the written consent of HDA;
  - the defect arises as a result of an act of god, fair wear and tear, or your misuse, abuse, unreasonable use, wilful damage, negligence, or abnormal storage of the Products or by any other causes unrelated to defective hardware or manufacturing;
  - where the serial number has been altered, defaced or removed;
  - where the warranty seal on the system has been altered, defaced or removed; or
  - where the Products differ from their description as a result of changes made to ensure they comply with applicable statutory or regulatory requirements.

## TRANSFERRING YOUR GUARANTEE TO SOMEONE ELSE

7. [HDA will not accept any liability under such guarantee unless you are the original customer or can produce a letter or chain of letters from the original customer and subsequent customers (where appropriate) transferring the benefit of the guarantee to you.]

## PRODUCTS THAT ARE NOT COVERED BY THIS GUARANTEE

8. This guarantee does not cover products sold and clearly marked "as is", "B-grade", or with faults. This guarantee does not apply to any system software that is preinstalled in the HDA hardware, or is subsequently provided via update or upgrade releases. Any and all HDA software is licensed to you under the terms of a separate end user licence agreement found here: [EULA Link]

## HOW THIS GUARANTEE WORKS WITH OUR EULA

9. We may void this guarantee if we reasonably believe that the HDA system has been used in a manner that violates terms of our separate End User Licence Agreement (EULA) for the HDA software. You assume all-risk and liabilities associated with the use of third party products in conjunction with the Products.

## YOUR STATUTORY RIGHTS

10. This guarantee is in addition to your statutory rights (including under the Consumer Rights Act) which are not affected by this guarantee

## GENERAL TERMS OF THIS GUARANTEE

- Except as provided in this guarantee, we shall have no liability to you in respect of the Products' failure to comply with the guarantee set out in paragraph 2.
- We reserve the right to amend or withdraw this guarantee at any time although for the avoidance of doubt any guarantees that are in existence at such a time will be honoured.
- These Conditions shall apply to any repaired or replacement Product supplied by us.

## GUARANTEE CONTACT INFORMATION

To contact (support@hdanywhere.com) or call HDANYWHERE Technical Support (call charges will depend on your telephone provider. Please check with your operator for exact charges). The team is available 9am - 5pm weekdays.

To help us handle your query promptly, please have your invoice number and model SKU and serial ready.

## Please give us your feedback

We love to hear ideas for how we might improve our products and your experiences using them. If we can make something better, we will, at the earliest opportunity. Whether that be a software or hardware change. So don't keep it to yourself, let us know. And if your idea gets used - we will credit you publicly and send you a nice gift to say thanks!

Use the **uControl App** to send us feedback,  
or go to [HDANYWHERE.com/feedback](https://www.hdanywhere.com/feedback)

HDANYWHERE

©2017 HD Connectivity Ltd, trading as HDANYWHERE® or its affiliates. All rights reserved.  
HDANYWHERE and MHUB 4K + logos are trademarks of HDANYWHERE® or its affiliates.