



Renkus-Heinz beam-steering technology, now in a passive column.

The UBX series from Renkus-Heinz delivers the precise coverage, high intelligibility, and renowned sound quality of their flagship Iconyx loudspeakers into the realm of passive column arrays. New for the UBX Series is our “Passive UniBeam Technology” which addresses each transducer with specially designed all-pass filter networks, gain shading, and additional frequency filtering in order to generate an asymmetrical vertical dispersion with constant directivity, delivering consistent front-to-back coverage with minimal side lobe artifacts.

The UBX Series utilizes state of the art neodymium 3” Full-Range drivers which allow for an incredibly small footprint. The narrow cabinet, combined with Passive UniBeam coverage, allows for plumb surface mounting via the included wall mount bracket, resulting in the least possible architectural intrusion. All models in the UBX Series are weather resistant (IP64) out of the box with the included gland/conduit knock out input cover, and feature high quality audio transformers for 70V/100V constant voltage operation in large, distributed audio systems.

Applications

- The UBX Series delivers consistent coverage, and great intelligibility to a wide range of applications.
- The UBX4’s small size and consistent vertical coverage makes it the ideal loudspeaker for K-12 classrooms.
- Inherent IP64 weather resistance and discrete size makes the UBX4 ideal for outdoor distributed audio systems in places like theme parks.
- Tight vertical dispersion, constant directivity deliver excellent performance for delay, or balcony fill loudspeaker for larger systems.

UBX4

The UBX4 is the smallest model in the UBX Series, but it still delivers an precise vertical pattern control, and an unmatched combination of features for a loudspeaker of its size. Passive UniBeam technology offers incredibly consistent coverage and constant directivity for such a small loudspeaker. Four high-quality neodymium transducers deliver the impeccable sound quality Renkus-Heinz audio solutions are known for. The included 60w 70/100v transformer, wall-mount bracket and standard weather resistance make it simple to integrate into any system design.

UBX Series

UBX4

Non-Powered Column Array with Passive UniBeam Technology



• Passive UniBeam Technology

Asymmetrical vertical dispersion, constant directivity, and inherent down angle deliver incredible coverage even when mounted plumb.

• High Quality Audio Components

3” Neodymium full-range drivers, crossover components, and transformers were all selected for impeccable audio performance.

• Out of the Box Simplicity

Included panable wall-mount bracket and inherent weather resistance means the UBX4 is ready to go as soon as its out of the box.

UBX4 Specifications

| | |
|-------------------------------|--|
| Frequency Response: | 150 Hz to 15 kHz (- 3 dB) 115-18 kHz (-10 dB) |
| Sensitivity: | 91 dB (1 W / 1 m) 78 dB (4 m, per EN54-24) |
| Impedance: | 12 Ohms |
| Power Handling: | 30 W (100 Hr per EN54-24) 55 W (AES) 110 W (PGM) 220 W (PEAK) |
| Transformer: | 70/100 V Transformer 8 W (800 Ω), 15 W (400 Ω), 30 W (200 Ω), 60 W (100 Ω) Taps - 70 V 15 W (800 Ω), 30 W (400 Ω), 60 W (200 Ω) Taps - 100 V |
| Maximum SPL: | 114 dB Peak @ 1 m 95 dB @ 4 m (through transformer per EN54-24) |
| Dispersion H: | 120° horizontal below 5 kHz, 90° above 5 kHz |
| Dispersion V: | 30° asymmetrical (+10°/-20°) with 7° average downtilt above 2.5kHz |
| Coverage Angles: | 500 Hz: 360 H x 240 V 1000 Hz: 182 H x 70 V 2000 Hz: 124 H x 43 V 4000 Hz: 154 H x 21 V |
| Transducers: | 4 x 3 in. / 77 mm, full-range, high sensitivity, treated paper cone driver |
| Connector: | Covered screw terminals |
| Enclosure: | Extruded aluminum |
| Grille: | Perforated, bent aluminum |
| Finish: | Black (RAL9011) or White (RAL9010) paint |
| Weather Rating: | IP64 with Salt Spray, Chlorine, and UV Resistance |
| Operating Temperature: | Minimum: -22° F / -30° C Maximum: 140° F / 60° C with no direct sun exposure |
| Mounting: | W-WALL-UBX Surface-mount pan bracket (included) W-WALL-UBX-PT pan/tilt bracket (optional) |
| Dimensions: | 4-3/8" (111.4 mm) w 17-1/8" (435 mm) h 4-3/4" (120.7 mm) d |
| Weight: | 10.2 lbs (4.6 kg) |

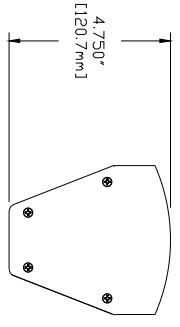
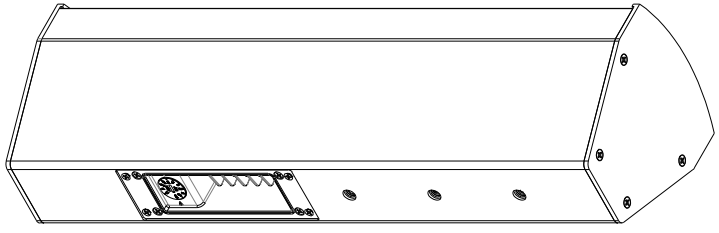
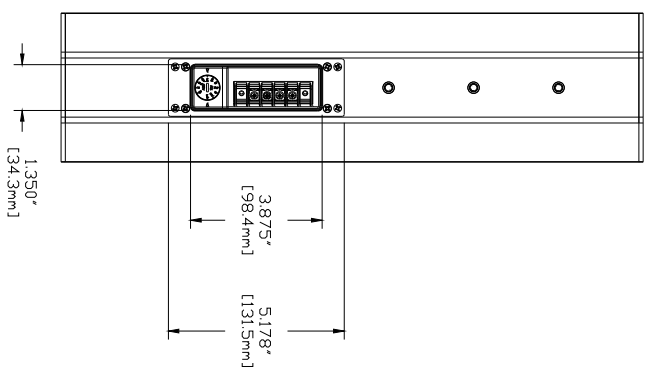
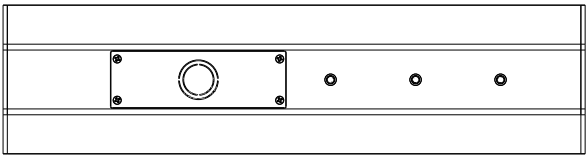
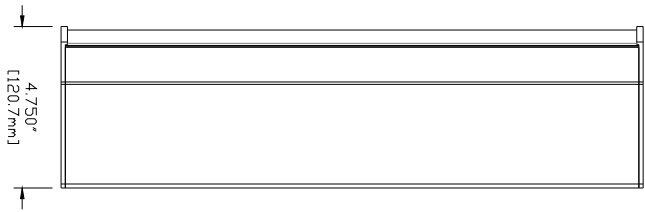
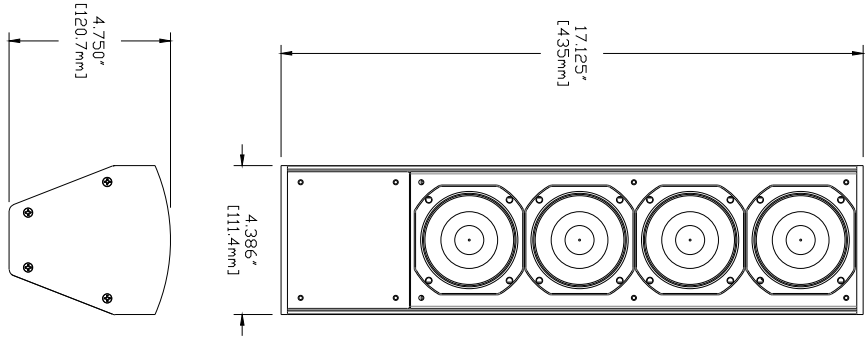

Measurements

1m on-axis Frequency Response

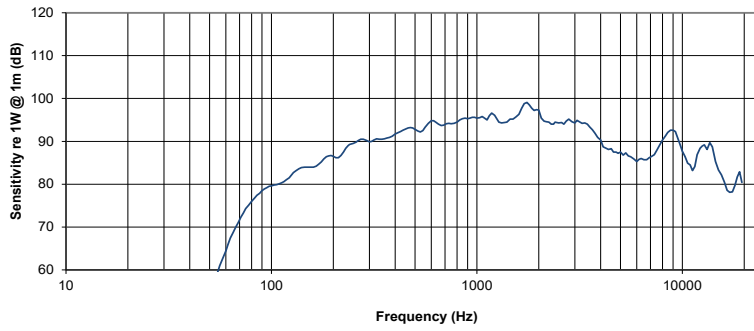

Impedance vs frequency

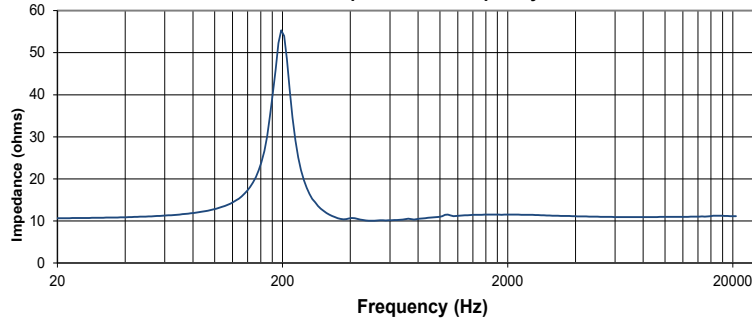

Beamwidth vs Frequency (@ 5m/16.4ft)

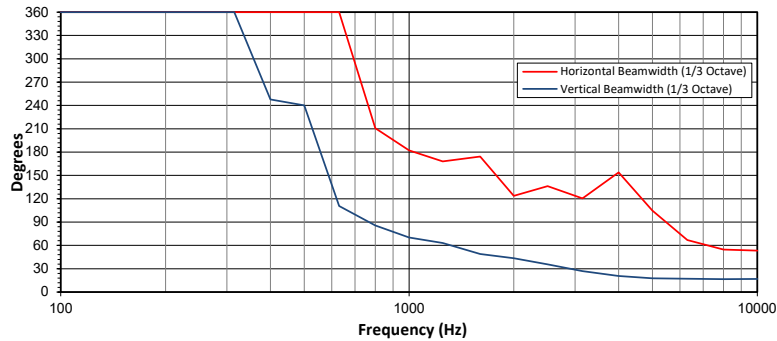

DI vs Frequency (@ 5m/16.4ft)

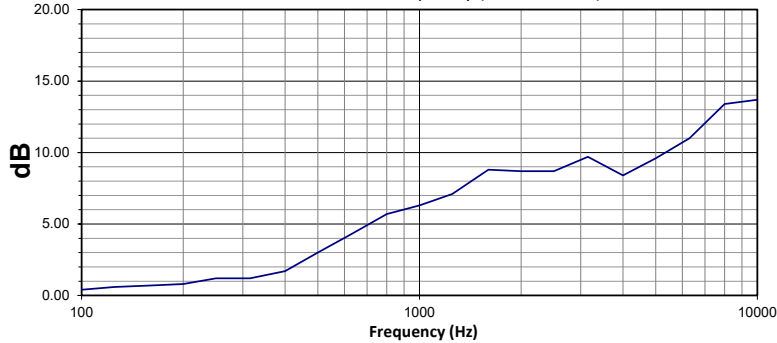

Measurements continued

Horizontal Off-axis Frequency Response, Normalized On-Axis

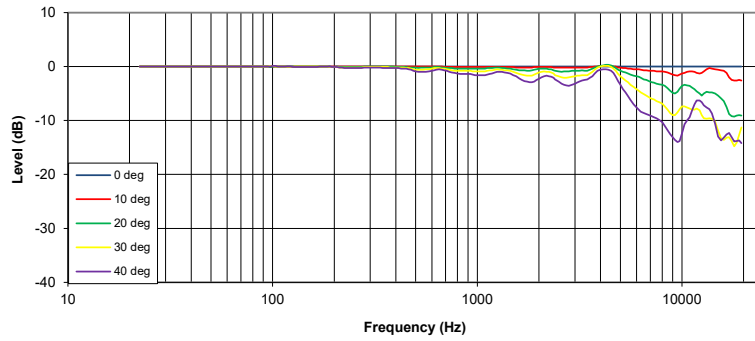

Lower Vertical Off-axis Frequency Response, Normalized On-Axis

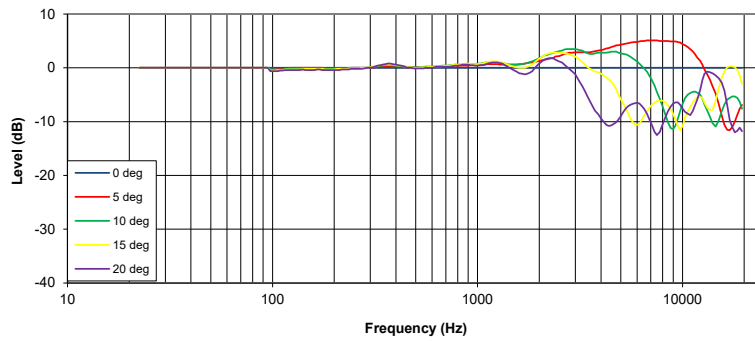

Upper Vertical Off-axis Frequency Response, Normalized On-Axis

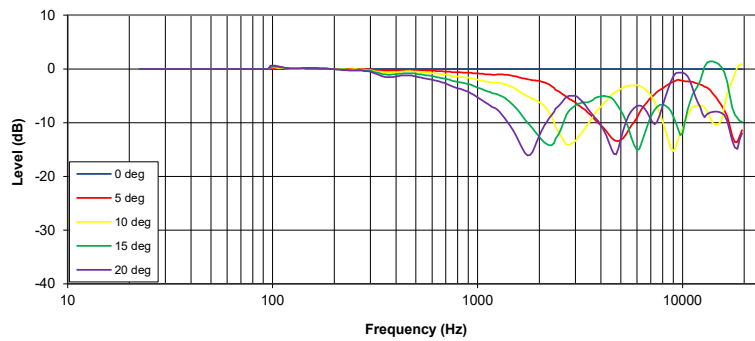

Measurements continued

250 Hz 1/3 Oct

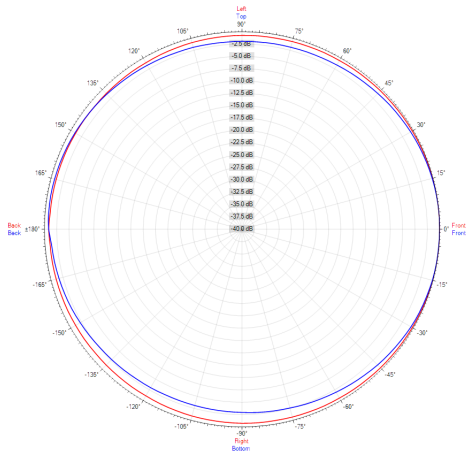

500 Hz 1/3 Oct

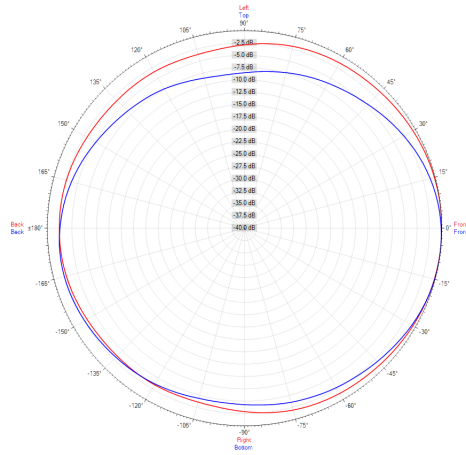

1 kHz 1/3 Oct

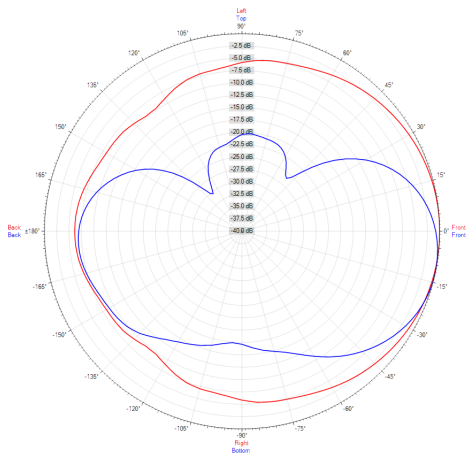

2 kHz 1/3 Oct

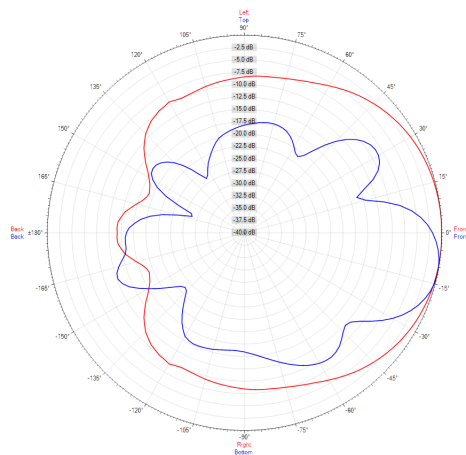

4 kHz 1/3 Oct

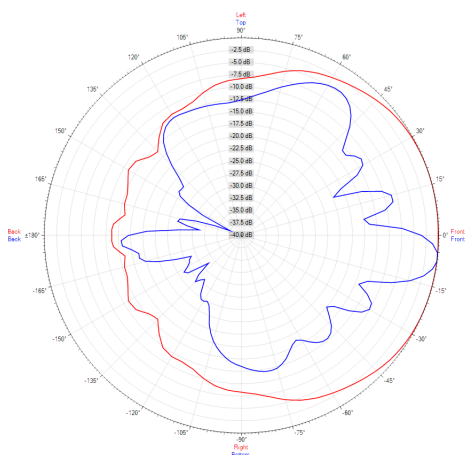

8 kHz 1/3 Oct

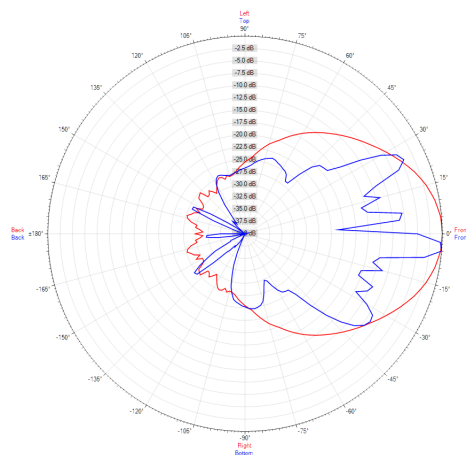

This page is intentionally blank.

This page is intentionally blank.